

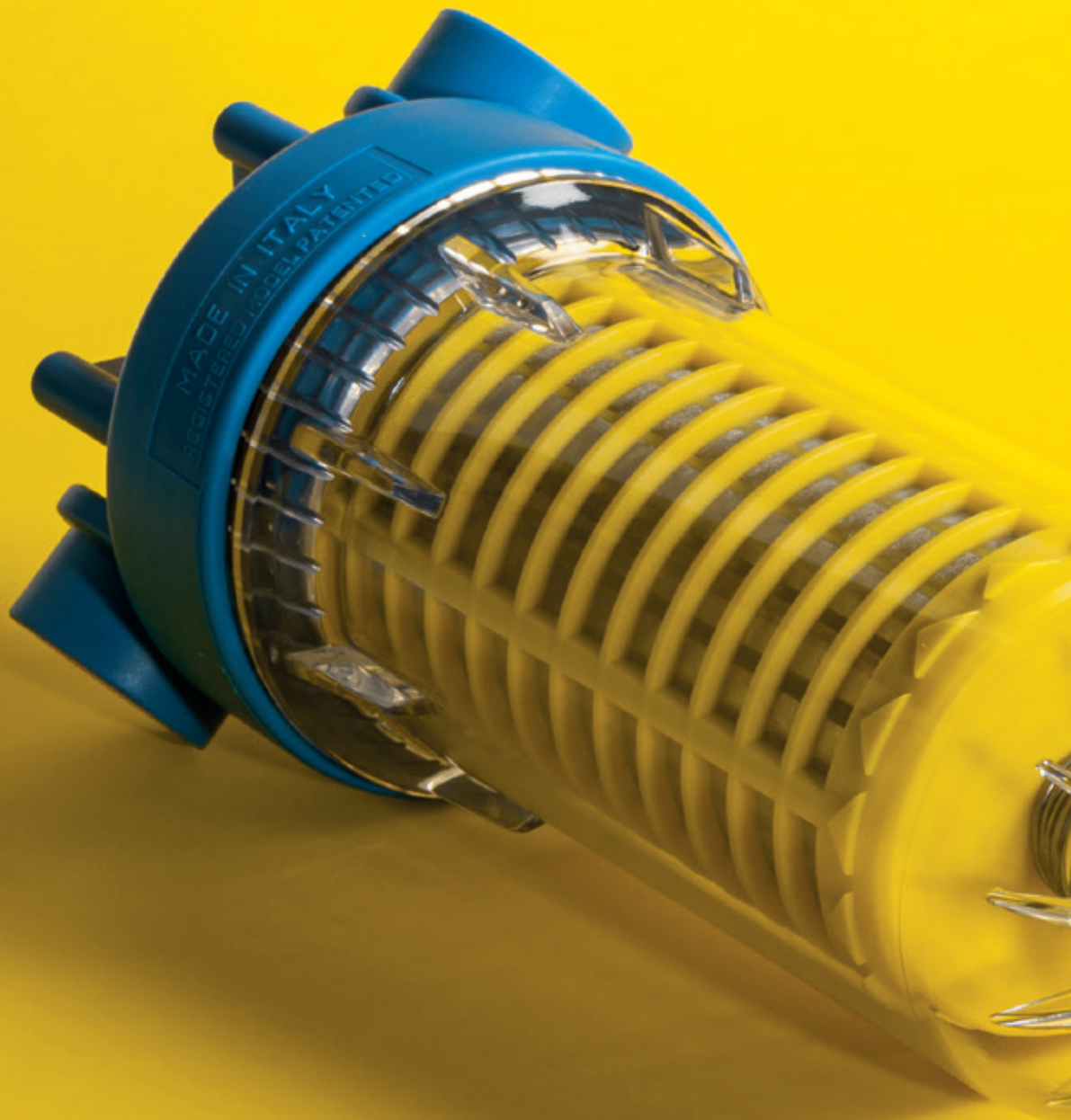

HYDRA

self-cleaning filter

TECHNICAL CATALOGUE



CERTIFICATIONS:



A range of self-cleaning filters is certified by IAPMO R&T against NSF/ANSI 42 - Material Safety and Structural Integrity only, 61, 372 - lead free, CSA B483.



Self-cleaning filters are tested and certified under the most stringent procedures worldwide, in compliance with the sanitary certifications DM25 -Italy-, ACS -France- and EAC/Ghostreghistracia -Russia-

OPEN TO
CLEAN



HYDRA

Self-cleaning filters with back-wash

The cleaning operations are simple and within reach for everyone: they can take place manually by opening the drain ball valve at the bottom of the filter, or automatically, thanks to the dedicated kit auto. Process efficiency is guaranteed by the drain system designed to block reflux of the ejected water.



POINT OF ENTRY



COLD WATER



HOT WATER



MAX WORKING PRESSURE

BSPP versions: 8 bar (116 psi) - 10 bar (145 psi) for K DP models

NPT versions: 8,6 bar (125 psi)

MIN WORKING PRESSURE

1,8 bar (26 psi)



MAX WORKING TEMPERATURE

HYDRA 45°C (113°F)

HYDRA HOT 80°C (176°F)

MIN WORKING TEMPERATURE

4°C (39,2°F)

THREADS TYPE

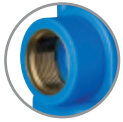

OT
BRASS BSPP

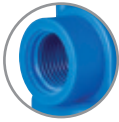

IN
PLASTIC BSPP

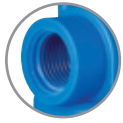

IN-NPT
PLASTIC NPT



MP
PLASTIC BSPP

TECHNICAL SPECIFICATIONS

HYDRA:

Selected raw materials, suitable for drinking water.

Head: reinforced polypropylene.

Bowl: PET.

O-ring: EPDM.

Breather-valve: body stainless steel, o-ring EPDM.

In/out brass threads: CW 617 N brass.

Discharge ball-valve: CW 614 N brass nickel plated.

Drain funnel: reinforced polypropylene.

Manometers (M models): radial type, pressure range 0-12 bar, 0-170 psi.

HYDRA K DP:

Selected raw materials, suitable for drinking water.

Head: CB 753 S brass.

Bowl: PET.

O-ring: EPDM.

Breather-valve: CW 614 N brass.

Discharge ball-valve: CW 617 N brass nickel plated.

Drain funnel: reinforced polypropylene.

Manometers (M models): radial type, pressure range 0-12 bar, 0-170 psi.

HYDRA HOT:

Head: reinforced nylon.

Bowl: reinforced nylon.

O-ring: EPDM.

Breather-valve: body stainless steel, o-ring EPDM.

Discharge ball-valve: CW 617 N brass nickel plated.

Drain funnel: reinforced polypropylene.

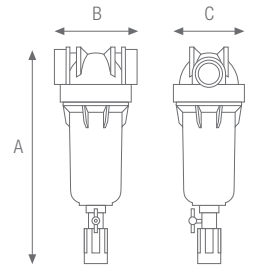

VERSIONS



HYDRA

HYDRA M

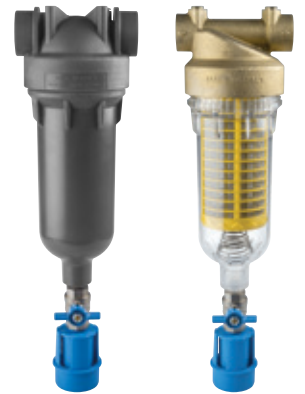

HYDRA HOT

HYDRA K DP

CARTRIDGES



RAH 90 mcr

RLH 90 mcr

RSH 50 mcr

RAH HOT
90 mcr

RAH stainless steel net cartridge - CODE RA5000020

RLH plastic net cartridge - CODE RA5000010

RSH pleated plastic net cartridge - CODE RA5000040

RAH HOT stainless steel net cartridge - CODE RA5080020

DRAIN FUNNEL

Back-flow
preventing device
UNI EN 1717-11/2002



HYDRA single-stage self-cleaning filters

HOUSINGS WITH BRASS BSPP THREADS

PART NUMBER	MODEL	NOMINAL FILTRATION mcr	IN/OUT	FLOW RATE l/h	DIMENSIONS mm		
					A	B	C
RA6000010	HYDRA 1/2" RLH 90 mcr OT	90	1/2"	3500	390	120	107
RA6000011	HYDRA 3/4" RLH 90 mcr OT	90	3/4"	5000	390	120	107
RA6000012	HYDRA 1" RLH 90 mcr OT	90	1"	6000	390	120	107
RA6000022	HYDRA 1"1/4 RLH 90 mcr OT	90	1"1/4	8000	415	120	107
RA6000013	HYDRA 1/2" RAH 90 mcr OT	90	1/2"	3500	390	120	107
RA6000014	HYDRA 3/4" RAH 90 mcr OT	90	3/4"	5000	390	120	107
RA6000015	HYDRA 1" RAH 90 mcr OT	90	1"	6000	390	120	107
RA6000024	HYDRA 1"1/4 RAH 90 mcr OT	90	1"1/4	8000	415	120	107
RA6000019	HYDRA 1/2" RSH 50 mcr OT	50	1/2"	3500	390	120	107
RA6000020	HYDRA 3/4" RSH 50 mcr OT	50	3/4"	5000	390	120	107
RA6000021	HYDRA 1" RSH 50 mcr OT	50	1"	6000	390	120	107
RA6000026	HYDRA 1"1/4 RSH 50 mcr OT	50	1"1/4	8000	415	120	107

HOUSINGS WITH PLASTIC BSPP THREADS

PART NUMBER	MODEL	NOMINAL FILTRATION mcr	IN/OUT	FLOW RATE l/h	DIMENSIONS mm		
					A	B	C
RA6000028	HYDRA 1/2" RLH 90 mcr IN	90	1/2"	3500	390	120	107
RA6000029	HYDRA 3/4" RLH 90 mcr IN	90	3/4"	5000	390	120	107
RA6000030	HYDRA 1" RLH 90 mcr IN	90	1"	6000	390	120	107
RA6000060	HYDRA 1/2" RLH 90 mcr MP	90	1/2"	3500	390	155	107
RA6000061	HYDRA 3/4" RLH 90 mcr MP	90	3/4"	5000	390	155	107
RA6000062	HYDRA 1" RLH 90 mcr MP	90	1"	6000	390	155	107
RA6000035	HYDRA 1/2" RAH 90 mcr IN	90	1/2"	3500	390	120	107
RA6000036	HYDRA 3/4" RAH 90 mcr IN	90	3/4"	5000	390	120	107
RA6000037	HYDRA 1" RAH 90 mcr IN	90	1"	6000	390	120	107
RA6000070	HYDRA 1/2" RAH 90 mcr MP	90	1/2"	3500	390	155	107
RA6000071	HYDRA 3/4" RAH 90 mcr MP	90	3/4"	5000	390	155	107
RA6000072	HYDRA 1" RAH 90 mcr MP	90	1"	6000	390	155	107
RA6000042	HYDRA 1/2" RSH 50 mcr IN	50	1/2"	3500	390	120	107
RA6000043	HYDRA 3/4" RSH 50 mcr IN	50	3/4"	5000	390	120	107
RA6000044	HYDRA 1" RSH 50 mcr IN	50	1"	6000	390	120	107
RA6000080	HYDRA 1/2" RSH 50 mcr MP	50	1/2"	3500	390	155	107
RA6000081	HYDRA 3/4" RSH 50 mcr MP	50	3/4"	5000	390	155	107
RA6000082	HYDRA 1" RSH 50 mcr MP	50	1"	6000	390	155	107

HOUSINGS WITH PLASTIC NPT THREADS

PART NUMBER	MODEL	NOMINAL FILTRATION mcr	IN/OUT	FLOW RATE l/h	DIMENSIONS mm		
					A	B	C
RA6000053	HYDRA 1/2" RLH 90 mcr NPT IN	90	1/2"	5000	390	120	107
RA6000033	HYDRA 3/4" RLH 90 mcr NPT IN	90	3/4"	5000	390	120	107
RA6000034	HYDRA 1" RLH 90 mcr NPT IN	90	1"	6000	390	120	107
RA6000054	HYDRA 1/2" RAH 90 mcr NPT IN	90	1/2"	5000	390	120	107
RA6000040	HYDRA 3/4" RAH 90 mcr NPT IN	90	3/4"	5000	390	120	107
RA6000041	HYDRA 1" RAH 90 mcr NPT IN	90	1"	6000	390	120	107
RA6000055	HYDRA 1/2" RSH 50 mcr NPT IN	50	1/2"	5000	390	120	107
RA6000047	HYDRA 3/4" RSH 50 mcr NPT IN	50	3/4"	5000	390	120	107
RA6000048	HYDRA 1" RSH 50 mcr NPT IN	50	1"	6000	390	120	107



HYDRA M single-stage self-cleaning filters with 2 manometers

HOUSINGS WITH BRASS BSPP THREADS

PART NUMBER	MODEL	NOMINAL FILTRATION mcr	IN/OUT	FLOW RATE l/h	DIMENSIONS mm		
					A	B	C
RA6000110	HYDRA M 1/2" RLH 90 mcr OT	90	1/2"	3500	445	120	107
RA6000111	HYDRA M 3/4" RLH 90 mcr OT	90	3/4"	5000	445	120	107
RA6000112	HYDRA M 1" RLH 90 mcr OT	90	1"	6000	445	120	107
RA6000113	HYDRA M 1"1/4 RLH 90 mcr OT	90	1"1/4	8000	460	120	107
RA6000115	HYDRA M 1/2" RAH 90 mcr OT	90	1/2"	3500	445	120	107
RA6000116	HYDRA M 3/4" RAH 90 mcr OT	90	3/4"	5000	445	120	107
RA6000117	HYDRA M 1" RAH 90 mcr OT	90	1"	6000	445	120	107
RA6000118	HYDRA M 1"1/4 RAH 90 mcr OT	90	1"1/4	8000	460	120	107
RA6000120	HYDRA M 1/2" RSH 50 mcr OT	50	1/2"	3500	445	120	107
RA6000121	HYDRA M 3/4" RSH 50 mcr OT	50	3/4"	5000	445	120	107
RA6000122	HYDRA M 1" RSH 50 mcr OT	50	1"	6000	445	120	107
RA6000123	HYDRA M 1"1/4 RSH 50 mcr OT	50	1"1/4	8000	460	120	107

HOUSINGS WITH PLASTIC BSPP THREADS

PART NUMBER	MODEL	NOMINAL FILTRATION mcr	IN/OUT	FLOW RATE l/h	DIMENSIONS mm		
					A	B	C
RA6000125	HYDRA M 1/2" RLH 90 mcr IN	90	1/2"	3500	445	120	107
RA6000126	HYDRA M 3/4" RLH 90 mcr IN	90	3/4"	5000	445	120	107
RA6000127	HYDRA M 1" RLH 90 mcr IN	90	1"	6000	445	120	107
RA6000134	HYDRA M 1/2" RAH 90 mcr IN	90	1/2"	3500	445	120	107
RA6000135	HYDRA M 3/4" RAH 90 mcr IN	90	3/4"	5000	445	120	107
RA6000136	HYDRA M 1" RAH 90 mcr IN	90	1"	6000	445	120	107
RA6000141	HYDRA M 1/2" RSH 50 mcr IN	50	1/2"	3500	445	120	107
RA6000142	HYDRA M 3/4" RSH 50 mcr IN	50	3/4"	5000	445	120	107
RA6000143	HYDRA M 1" RSH 50 mcr IN	50	1"	6000	445	120	107

HOUSINGS WITH PLASTIC NPT THREADS

PART NUMBER	MODEL	NOMINAL FILTRATION mcr	IN/OUT	FLOW RATE l/h	DIMENSIONS mm		
					A	B	C
RA6000130	HYDRA M 3/4" RLH 90 mcr NPT IN	90	3/4"	5000	445	120	107
RA6000133	HYDRA M 1" RLH 90 mcr NPT IN	90	1"	6000	445	120	107
RA6000139	HYDRA M 3/4" RAH 90 mcr NPT IN	90	3/4"	5000	445	120	107
RA6000140	HYDRA M 1" RAH 90 mcr NPT IN	90	1"	6000	445	120	107
RA6000146	HYDRA M 3/4" RSH 50 mcr NPT IN	50	3/4"	5000	445	120	107
RA6000147	HYDRA M 1" RSH 50 mcr NPT IN	50	1"	6000	445	120	107



HYDRA K DP single-stage self-cleaning filters

HOUSINGS WITH BRASS BSPP THREADS

PART NUMBER	MODEL	NOMINAL FILTRATION mcr	IN/OUT	FLOW RATE l/h	DIMENSIONS mm		
					A	B	C
RA6000801	HYDRA K DP 3/4" RLH 90 mcr	90	3/4"	5000	430	120	107
RA6000802	HYDRA K DP 1" RLH 90 mcr	90	1"	6000	430	120	107
RA6000803	HYDRA K DP 3/4" RAH 90 mcr	90	3/4"	5000	430	120	107
RA6000804	HYDRA K DP 1" RAH 90 mcr	90	1"	6000	430	120	107
RA6000805	HYDRA K DP 3/4" RSH 50 mcr	50	3/4"	5000	430	120	107
RA6000806	HYDRA K DP 1" RSH 50 mcr	50	1"	6000	430	120	107



HYDRA K DP M single-stage self-cleaning filters with 2 manometers

HOUSINGS WITH BRASS BSPP THREADS

PART NUMBER	MODEL	NOMINAL FILTRATION mcr	IN/OUT	FLOW RATE l/h	DIMENSIONS mm		
					A	B	C
RA6000811	HYDRA K DP M 3/4" RLH 90 mcr	90	3/4"	5000	460	120	107
RA6000812	HYDRA K DP M 1" RLH 90 mcr	90	1"	6000	460	120	107
RA6000813	HYDRA K DP M 3/4" RAH 90 mcr	90	3/4"	5000	460	120	107
RA6000814	HYDRA K DP M 1" RAH 90 mcr	90	1"	6000	460	120	107
RA6000815	HYDRA K DP M 3/4" RSH 50 mcr	50	3/4"	5000	460	120	107
RA6000816	HYDRA K DP M 1" RSH 50 mcr	50	1"	6000	460	120	107



HYDRA HOT single-stage self-cleaning filters

HOUSINGS WITH PLASTIC BSPP THREADS

PART NUMBER	MODEL	NOMINAL FILTRATION mcr	IN/OUT	FLOW RATE l/h	DIMENSIONS mm		
					A	B	C
RA6000001	HYDRA HOT 1/2" RAH 90 mcr IN	90	1/2"	3500	390	120	107
RA6000002	HYDRA HOT 3/4" RAH 90 mcr IN	90	3/4"	5000	390	120	107
RA6000003	HYDRA HOT 1" RAH 90 mcr IN	90	1"	6000	390	120	107
RA6000005	HYDRA HOT 3/4" RAH 90 mcr NPT IN	90	3/4"	5000	390	120	107
RA6000006	HYDRA HOT 1" RAH 90 mcr NPT IN	90	1"	6000	390	120	107



A range of housings is certified by IAPMO R&T against NSF/ANSI Standards 42 - structural integrity only - and CSA B483.1 structural integrity only.

HYDRA DS

Self-cleaning filters with back-wash and with rotational connection group

Range of self-cleaning filters, performing all features of the standard HYDRA range, provided with 360° rotational connection group for easy installation to horizontal or vertical running pipes.

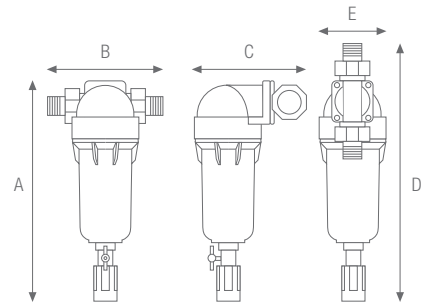

ROTATIONAL GROUP TYPE



VERSIONS



HYDRA DS MP

HYDRA DS MO

CARTRIDGES



RAH 90 mcr

RLH 90 mcr

RSH 50 mcr

RAH stainless steel net cartridge - CODE RA5000020
 RLH plastic net cartridge - CODE RA5000010
 RSH pleated plastic net cartridge - CODE RA5000040

TECHNICAL SPECIFICATIONS

Selected raw materials, suitable for drinking water.
 Head: reinforced polypropylene.
 Bowl: PET.
 O-ring: EPDM.
 Breather-valve: body stainless steel, o-ring EPDM.
 MP plastic rotational connection group: reinforced nylon.
 MO brass rotational connection group: CW 614 N brass.
 Rotational connection group gaskets: NBR.
 Discharge ball-valve: CW 614 N brass nickel plated.
 Drain funnel: reinforced polypropylene.

DRAIN FUNNEL

Back-flow preventing device
 UNI EN 1717-11/2002





HYDRA DS MP single-stage self-cleaning filters with plastic rotational group
 PLASTIC ROTATIONAL GROUP

PART NUMBER	MODEL	NOMINAL FILTRATION mcr	IN/OUT	FLOW RATE l/h	DIMENSIONS mm				
					A	B	C	D	E
RA6000601	HYDRA DS MP 3/4" - 1" RLH 90 mcr	90	3/4" - 1"	5000	428	170	168	479	107
RA6000602	HYDRA DS MP 3/4" - 1" RAH 90 mcr	90	3/4" - 1"	5000	428	170	168	479	107
RA6000603	HYDRA DS MP 3/4" - 1" RSH 50 mcr	50	3/4" - 1"	5000	428	170	168	479	107



HYDRA DS MO single-stage self-cleaning filters with brass rotational group
 BRASS ROTATIONAL GROUP

PART NUMBER	MODEL	NOMINAL FILTRATION mcr	IN/OUT	FLOW RATE l/h	DIMENSIONS mm				
					A	B	C	D	E
RA6000604	HYDRA DS MO 3/4" RLH 90 mcr	90	3/4"	4000	428	170	168	479	107
RA6000605	HYDRA DS MO 1" RLH 90 mcr	90	1"	5000	428	170	168	479	107
RA6000606	HYDRA DS MO 3/4" RAH 90 mcr	90	3/4"	4000	428	170	168	479	107
RA6000607	HYDRA DS MO 1" RAH 90 mcr	90	1"	5000	428	170	168	479	107
RA6000608	HYDRA DS MO 3/4" RSH 50 mcr	50	3/4"	4000	428	170	168	479	107
RA6000609	HYDRA DS MO 1" RSH 50 mcr	50	1"	5000	428	170	168	479	107

HYDRA DUO | TRIO

Multi-stage self-cleaning filters with back-wash

Exclusive multi-stage filters with self-cleaning pre-filter, for dual and triple stage water filtration and treatment. Second and third stages housings fit to both standard SX (DOE) cartridges and to proprietary BX cartridges.



POINT OF ENTRY



COLD WATER



MAX WORKING PRESSURE

BSPP versions: 8 bar (116 psi)

NPT versions: 8,6 bar (125 psi)

MIN WORKING PRESSURE

1,8 bar (26 psi)



MAX WORKING TEMPERATURE

45°C (113°F)

MIN WORKING TEMPERATURE

4°C (39,2°F)

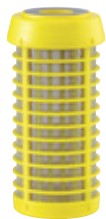
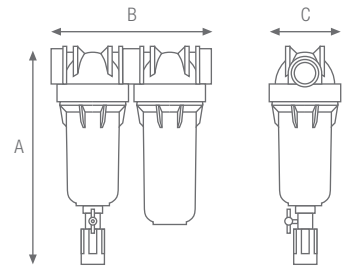

RAH 90 mcr
stainless steel net cartridge
CODE RA5000020

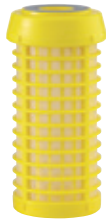

RLH 90 mcr
plastic net cartridge
CODE RA5000010



RSH 50 mcr
pleated plastic net cartridge
CODE RA5000040

CARTRIDGES

TECHNICAL SPECIFICATIONS

Selected raw materials,
suitable for drinking water.
Head: reinforced polypropylene.

Bowl: PET.

O-rings: EPDM.

Breather-valve: body stainless steel, o-ring EPDM.

In/out brass threads: CW 614 N brass.

Discharge ball-valve: CW 614 N brass nickel plated.

Drain funnel: reinforced polypropylene.



THREADS TYPE

OT
BRASS BSPP



IN
PLASTIC BSPP



IN-NPT
PLASTIC NPT

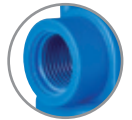

VERSIONS



HYDRA DUO



HYDRA TRIO

DRAIN FUNNEL

Back-flow
preventing device
UNI EN 1717-11/2002



HYDRA DUO multi-stage self-cleaning filters

HOUSINGS WITH BRASS BSPP THREADS

PART NUMBER	MODEL	NOMINAL FILTRATION mcr	IN/OUT	DIMENSIONS mm		
				A	B	C
RA6096143	HYDRA DUO RLH 1/2" OT	90	1/2"	390	228	107
RA6096153	HYDRA DUO RLH 3/4" OT	90	3/4"	390	228	107
RA6096163	HYDRA DUO RLH 1" OT	90	1"	390	228	107
RA6096213	HYDRA DUO RAH 1/2" OT	90	1/2"	390	228	107
RA6096223	HYDRA DUO RAH 3/4" OT	90	3/4"	390	228	107
RA6096233	HYDRA DUO RAH 1" OT	90	1"	390	228	107
RA6096171	HYDRA DUO RSH 1/2" OT	50	1/2"	390	228	107
RA6096172	HYDRA DUO RSH 3/4" OT	50	3/4"	390	228	107
RA6096173	HYDRA DUO RSH 1" OT	50	1"	390	228	107

HOUSINGS WITH PLASTIC BSPP THREADS

PART NUMBER	MODEL	NOMINAL FILTRATION mcr	IN/OUT	DIMENSIONS mm		
				A	B	C
RA6096142	HYDRA DUO RLH 1/2" IN	90	1/2"	390	228	107
RA6096152	HYDRA DUO RLH 3/4" IN	90	3/4"	390	228	107
RA6096162	HYDRA DUO RLH 1" IN	90	1"	390	228	107
RA6096212	HYDRA DUO RAH 1/2" IN	90	1/2"	390	228	107
RA6096222	HYDRA DUO RAH 3/4" IN	90	3/4"	390	228	107
RA6096232	HYDRA DUO RAH 1" IN	90	1"	390	228	107
RA6096175	HYDRA DUO RSH 1/2" IN	50	1/2"	390	228	107
RA6096182	HYDRA DUO RSH 3/4" IN	50	3/4"	390	228	107
RA6096192	HYDRA DUO RSH 1" IN	50	1"	390	228	107

HOUSINGS WITH PLASTIC NPT THREADS

PART NUMBER	MODEL	NOMINAL FILTRATION mcr	IN/OUT	DIMENSIONS mm		
				A	B	C
RA6096151	HYDRA DUO RLH 3/4" NPT IN	90	3/4"	390	228	107
RA6096161	HYDRA DUO RLH 1" NPT IN	90	1"	390	228	107
RA6096221	HYDRA DUO RAH 3/4" NPT IN	90	3/4"	390	228	107
RA6096231	HYDRA DUO RAH 1" NPT IN	90	1"	390	228	107
RA6096181	HYDRA DUO RSH 3/4" NPT IN	50	3/4"	390	228	107
RA6096191	HYDRA DUO RSH 1" NPT IN	50	1"	390	228	107



HYDRA TRIO multi-stage self-cleaning filters

HOUSINGS WITH BRASS BSPP THREADS

PART NUMBER	MODEL	NOMINAL FILTRATION mcr	IN/OUT	DIMENSIONS mm		
				A	B	C
RA6095143	HYDRA TRIO RLH 1/2" OT	90	1/2"	390	336	107
RA6095153	HYDRA TRIO RLH 3/4" OT	90	3/4"	390	336	107
RA6095163	HYDRA TRIO RLH 1" OT	90	1"	390	336	107
RA6095113	HYDRA TRIO RAH 1/2" OT	90	1/2"	390	336	107
RA6095223	HYDRA TRIO RAH 3/4" OT	90	3/4"	390	336	107
RA6095233	HYDRA TRIO RAH 1" OT	90	1"	390	336	107
RA6095173	HYDRA TRIO RSH 1/2" OT	50	1/2"	390	336	107
RA6095183	HYDRA TRIO RSH 3/4" OT	50	3/4"	390	336	107
RA6095193	HYDRA TRIO RSH 1" OT	50	1"	390	336	107

HOUSINGS WITH PLASTIC BSPP THREADS

PART NUMBER	MODEL	NOMINAL FILTRATION mcr	IN/OUT	DIMENSIONS mm		
				A	B	C
RA6095142	HYDRA TRIO RLH 1/2" IN	90	1/2"	390	336	107
RA6095152	HYDRA TRIO RLH 3/4" IN	90	3/4"	390	336	107
RA6095162	HYDRA TRIO RLH 1" IN	90	1"	390	336	107
RA6095112	HYDRA TRIO RAH 1/2" IN	90	1/2"	390	336	107
RA6095222	HYDRA TRIO RAH 3/4" IN	90	3/4"	390	336	107
RA6095232	HYDRA TRIO RAH 1" IN	90	1"	390	336	107
RA6095172	HYDRA TRIO RSH 1/2" IN	50	1/2"	390	336	107
RA6095182	HYDRA TRIO RSH 3/4" IN	50	3/4"	390	336	107
RA6095192	HYDRA TRIO RSH 1" IN	50	1"	390	336	107

HOUSINGS WITH PLASTIC NPT THREADS

PART NUMBER	MODEL	NOMINAL FILTRATION mcr	IN/OUT	DIMENSIONS mm		
				A	B	C
RA6095141	HYDRA TRIO RLH 3/4" NPT IN	90	3/4"	390	336	107
RA6095151	HYDRA TRIO RLH 1" NPT IN	90	1"	390	336	107
RA6095221	HYDRA TRIO RAH 3/4" NPT IN	90	3/4"	390	336	107
RA6095231	HYDRA TRIO RAH 1" NPT IN	90	1"	390	336	107
RA6095181	HYDRA TRIO RSH 3/4" NPT IN	50	3/4"	390	336	107
RA6095191	HYDRA TRIO RSH 1" NPT IN	50	1"	390	336	107



HYDRA
self-cleaning filter

 **ATLAS FILTRI**[®]
improving water

www.atlasfiltri.com